

# INTERNATIONAL

High Power Receiver

## CR-W400U Operating Instructions



Please read these instructions carefully before using this product and save this manual for future use.



**Panasonic** welcomes you to our ever growing family of electronic product owners. We know that this product will bring you many hours of enjoyment. Our reputation is built on precise electronic and mechanical engineering, manufactured with carefully selected components and assembled by people who take pride in their work. Once you discover the quality, reliability, and value we have built into this product, you too will be proud to be a member of our family.

---

## Use This Equipment Safely

### **When Driving**

Keep the volume level low enough to be aware of road and traffic conditions.

### **When Washing Vehicle**

Do not expose the equipment, including the speakers to water or excessive moisture. This could cause electrical shorts, fire or other damage.

### **When Parked**

Parking in direct sunlight can produce very high temperatures inside your vehicle. Give the interior a chance to cool down before switching the unit on.

### **Use the Proper Power Supply**

This equipment is designed to operate off a 12 volt, negative ground battery system (the normal system in a North American vehicle.)

### **Use Authorized Service centers**

Do not attempt to disassemble or adjust this precision equipment. Please refer to the Service center list included with this product for service assistance.

### **For Installation**

The product should be installed in a horizontal position with the front end up at a convenient angle, but not more than 30°.

---

Find the model number and serial number on either the back or bottom of the unit. Please record them in the space below and retain this booklet as a permanent record of your purchase to aid in identification in case of theft.

MODEL NUMBER CR-W400U SERIAL NUMBER \_\_\_\_\_

DATE PURCHASED \_\_\_\_\_ FROM \_\_\_\_\_

# Contents

Use This Equipment Safely .....Page 2

---

**Power and Sound Controls** .....4  
How to adjust the volume, mute, balance, and tone for best listening



**Radio Basics**.....6  
Mode selection, manual and automatic tuning, band selection, preset stations

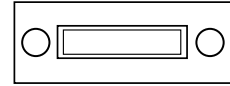

**Clock Basics**.....9  
Setting the time, selecting the clock display

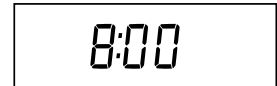

**In case of Malfunction** .....10

---

**Installation Guide**.....11  
Step-by-step procedures, electrical connections

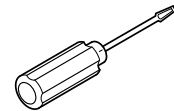

**Troubleshooting** .....15  
Troubleshooting tips, where to get service help



**Specifications** .....17

**Part 15 of the FCC Rules** .....17

---

# Power and Sound Controls

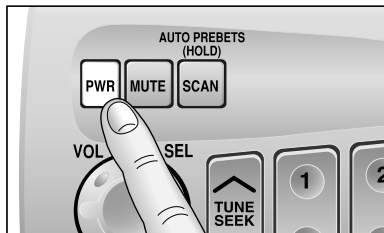

## Power

If the vehicle is not running yet, turn the key in the ignition until the accessory indicator lights. Press **[PWR]** to switch on the power.

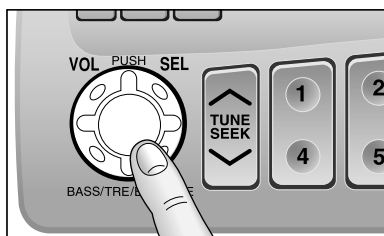

## Volume

- Press the knob to select the volume mode and then turn it clockwise or counterclockwise to adjust the volume level.

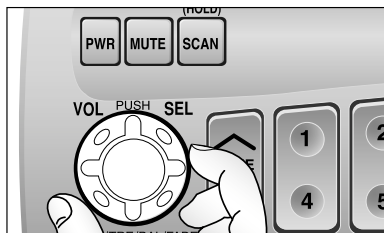
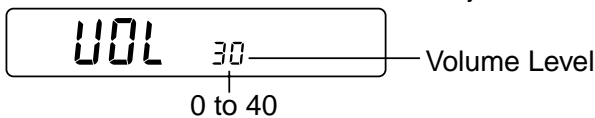

### Anti-Volume-Blast Circuit

At power on, the volume returns to the previous level slowly if the level was at 20 or higher.

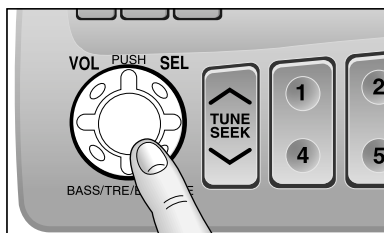

## Changing Audio Modes

Press this knob **[SEL]** to change the audio mode as follows.

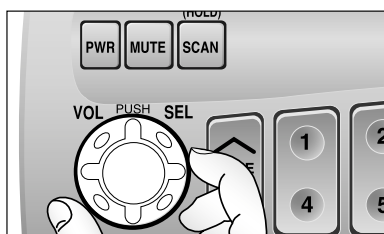

## Bass and Treble

Press the knob to select the BASS or TREBLE mode and then turn it clockwise or counterclockwise to increase or decrease the bass/treble level.

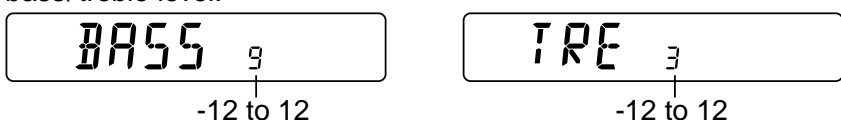

# Power and Sound Controls (continued)

## Balance

Press the knob to select the BALANCE mode and then turn it clockwise or counterclockwise to shift the sound volume to the right or left speakers.

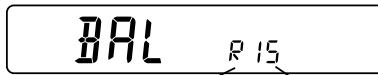

(R: Right, L: Left)



## Fader

Press the knob to select the FADER mode and then turn it clockwise or counterclockwise to shift the sound volume to the front or rear speakers.



(F: Front, R: Rear)



**Note:** In the audio mode (BASS/TRE/BAL/FADE), the display will return to regular operation mode when there is no input for more than 5 seconds (2 seconds in the VOL mode).

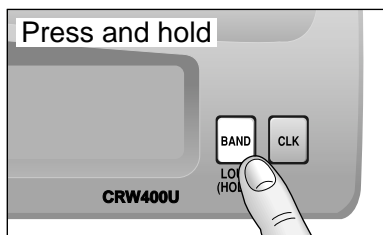

## Tone Enhancement (Loudness)

- Press and hold **[BAND]** (LOUD) for more than 2 seconds to enhance bass and treble tones when listening at low or medium volume.



- Press and hold **[BAND]** (LOUD) for more than 2 seconds again to deactivate when listening at higher volumes.

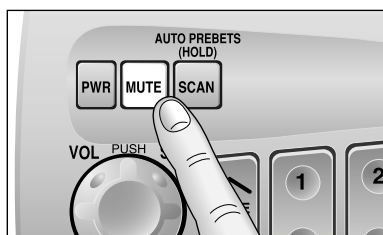

## Mute

- Press **[MUTE]** to mute the sound completely.

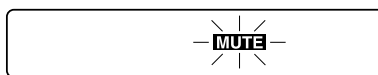

- Press **[MUTE]** again to cancel.

# Radio Basics

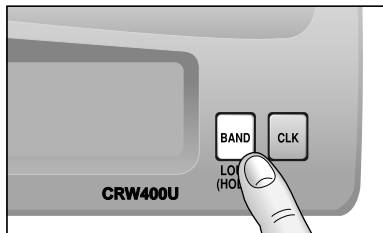

## Selecting a Band

Press **[BAND]** to change the band setting as follows.

FM1 → FM2 → W/B → AM  
(Weather Band)

"ST" indicator lights when FM stereo broadcast is available.

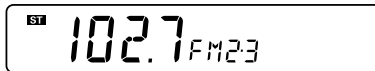

## Manual Tuning

Press **[TUNE ^]** or **[TUNE v]** to tune in a higher or lower frequency.



## Seek Tuning

Press and hold **[SEEK ^]** or **[SEEK v]** for more than 0.5 seconds, then release it.

Seek tuning will automatically stop when a signal of the next broadcast station is received.

# Radio Basics (continued)

## Station Preset

FM1, FM2 and AM can save maximum 6 stations each in their preset station memories.

**Caution:** To ensure safety, never attempt to preset stations while you are driving.

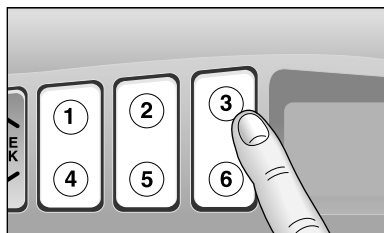
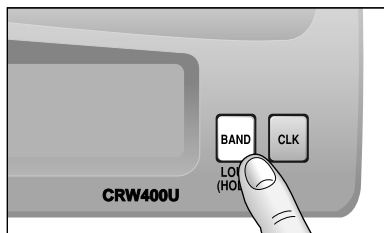
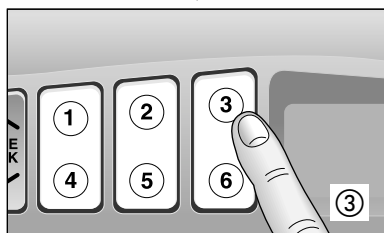
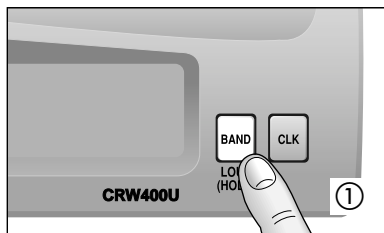

## Manual Station Preset

- ① Press **[BAND]** to select a desired band.
- ② Use manual or seek tuning to find a station to be stored in the preset memory.
- ③ Press and hold one of the preset buttons [1] to [6] until the display blinks once.

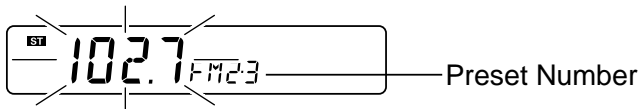

**Note:** You can change the memory setting by repeating the above procedure.

## Auto Station Preset

Select a band and press and hold **[SCAN]** (AUTO PRESETS) for more than 2 seconds.

- The 6 strongest available stations will be automatically saved in the memory on preset buttons [1] to [6].
- Once set, the preset stations are sequentially scanned for 5 seconds each.

### Notes:

- In Auto Station Preset mode, only FM2 is available for FM stations. (FM1 is not available.)
- Auto Station Preset is not activated in Weather Band.
- Any stations preset previously on the selected band will be erased.

## Tuning in a Preset Station

Press the corresponding preset buttons [1] to [6] to tune in a preset station.



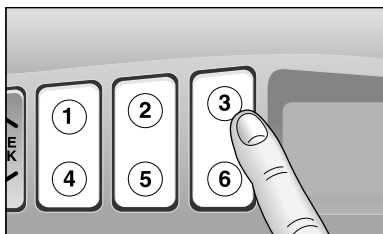

## Tuning in a Weather Band Station

Press any of the buttons [1] to [6] to monitor the preset station.

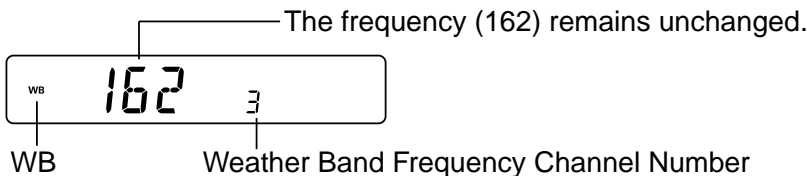

**Note:** The weather band (CH1-6) has been preset. CH7 is selected by pressing [^] or [v].

## Weather Band Stations

National Weather Radio Broadcasts from over 380 locations throughout the U.S. on seven VHF/FM frequencies.

Tune to weather band to receive continuous weather information 24 hours a day on one of the following frequencies.

1. 162.550 MHz
2. 162.400 MHz
3. 162.475 MHz
4. 162.425 MHz
5. 162.450 MHz
6. 162.500 MHz
7. 162.525 MHz

Occasionally the frequency of an existing or planned station must be changed because of unexpected radio frequency interference with adjacent NOAA Weather Radio Stations and/or with other Government or Commercial Operations within the area. If you have a question concerning NOAA Weather Radio, please contact your nearest National Weather Service Office.

# Clock Basics (The clock system is 12-hours.)

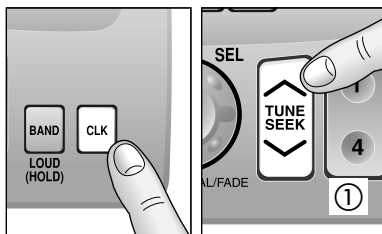
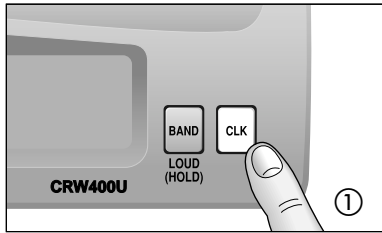

or

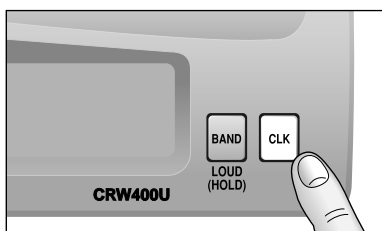
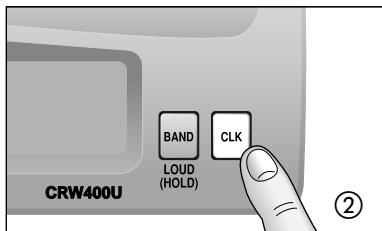
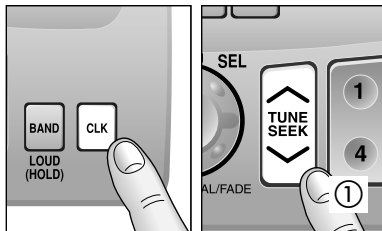

## Initial Time

- ① Press and hold [CLK] to set time. Display blinks, and the time setting mode is activated.  
Press [V] to set the hour.  
Press [^] to set the minute.  
(Hold [V] or [^] to change numbers rapidly.)

- ② Once the time has been set, release [CLK].

**Note:** When the clock is not set yet, "SET" is displayed.

## Time Reset

When you want to reset the time, repeat steps ① and ② above.

## Clock Display

Press [CLK] to display the current time.  
Press [CLK] again to return to previous display.

**Note:** The current time will be displayed at all the time even the power of the radio is turned off.

# In Case of Malfunction

---

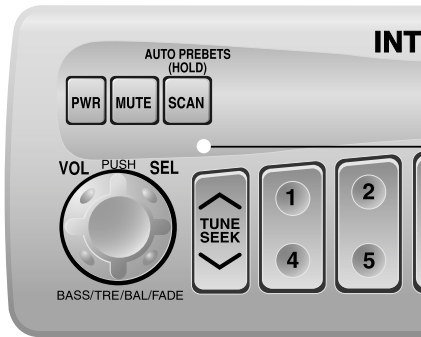

## Reset Switch

If the unit does not respond when the function buttons are pressed, press the reset switch with a small pointed object, such as a pencil point. This will restore the unit to its default settings. All previously stored memory settings will be erased. Repeat the necessary steps in the previous pages to reprogram the clock and memory settings. If pressing the reset switch does not restore normal operation, please return the radio to the nearest authorized service center for service.

# Installation Guide

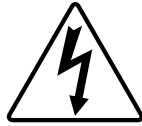

## WARNING

This installation information is designed for experienced installers and is not intended for non-technical individuals. It does not contain warnings or cautions of potential dangers in attempting to install this product.

Any attempt to install this product in a motor vehicle by anyone other than qualified installer could cause damage to the electrical system and could result in serious personal injury or death.

### ❑ Overview

This equipment should be installed by a professional. However, if you plan to install this unit yourself, your first step is to decide where to install it. The instructions in these pages will guide you through the remaining steps: **(Please refer to "WARNING" statement above).**

- Identify and label the vehicle wires.
- Connect the vehicle wires to the wires of the power connector.
- Install the unit in the dash.
- Check the operation of the unit.

If you do encounter problems, please consult your nearest authorized dealer.

---

**Caution:** This unit will operate with a 12 volt DC negative ground auto battery system only. Do not attempt to use it in any other system. Doing so could cause serious damage.

---

Before you begin installation, look for the following items included in the packing with your unit.

- **Installation Hardware** ..... Needed for in-dash installation

### ❑ Installation Hardware

No.	Item	Diagram	Qty
①	Mounting Collar		1

## Installation Procedures

- When bending the mounting tab of the mounting collar with a screwdriver, be careful not to injure your hands and fingers.
- We strongly recommend you to wear gloves for installation work to protect yourself from injuries.

**Note:** Disconnect the cable from the negative (-) battery terminal.

### 1. Secure the Mounting Collar ①.

Insert Mounting Collar ① into the vehicle's dashboard, and bend mounting tabs out with a screwdriver.

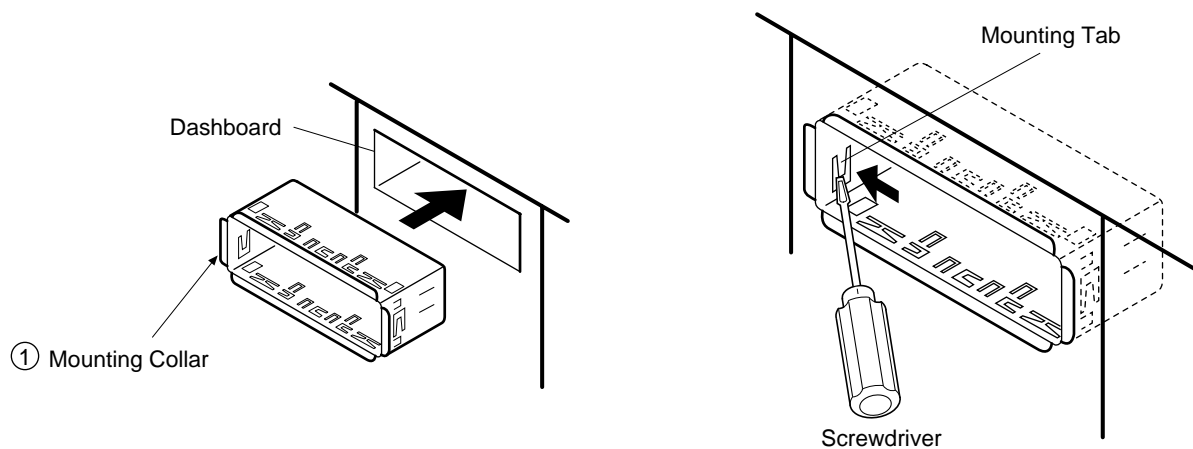

### 2. Secure the rear of the unit.

- a) Insert Power Connector to the unit.
- b) Check the electrical connection by referring to this operating instructions.
- c) Insert the unit into Mounting Collar ① and push it in until "click" is heard.

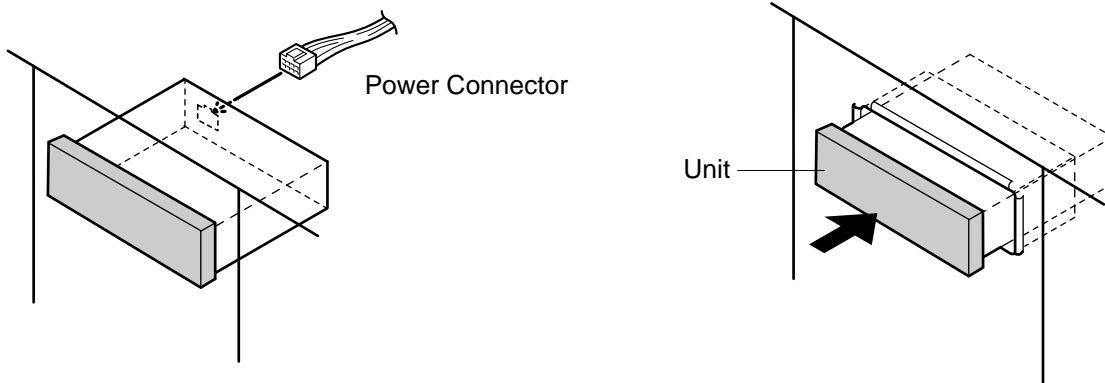

---

## To remove the unit from the vehicle's dashboard

Insert each removal tool and pull.

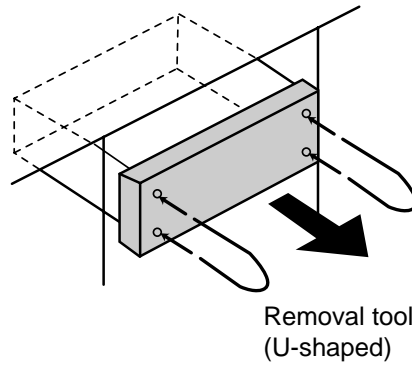

**Note:** Do not lose removal tools. They will be needed to remove the unit from the vehicle's dashboard.

# Electrical Connections

## Cautions:

- This product is designed to operate with a 12-volt negative ground battery system.
- To prevent damage to the unit, be sure to follow the connection diagram below.
- Do not insert the power connector into the unit until the wiring is completed.
- Be sure to insulate any exposed wires from a possible short-circuit from the vehicle chassis. Bundle all cables and keep cable terminals free from touching any metal parts.

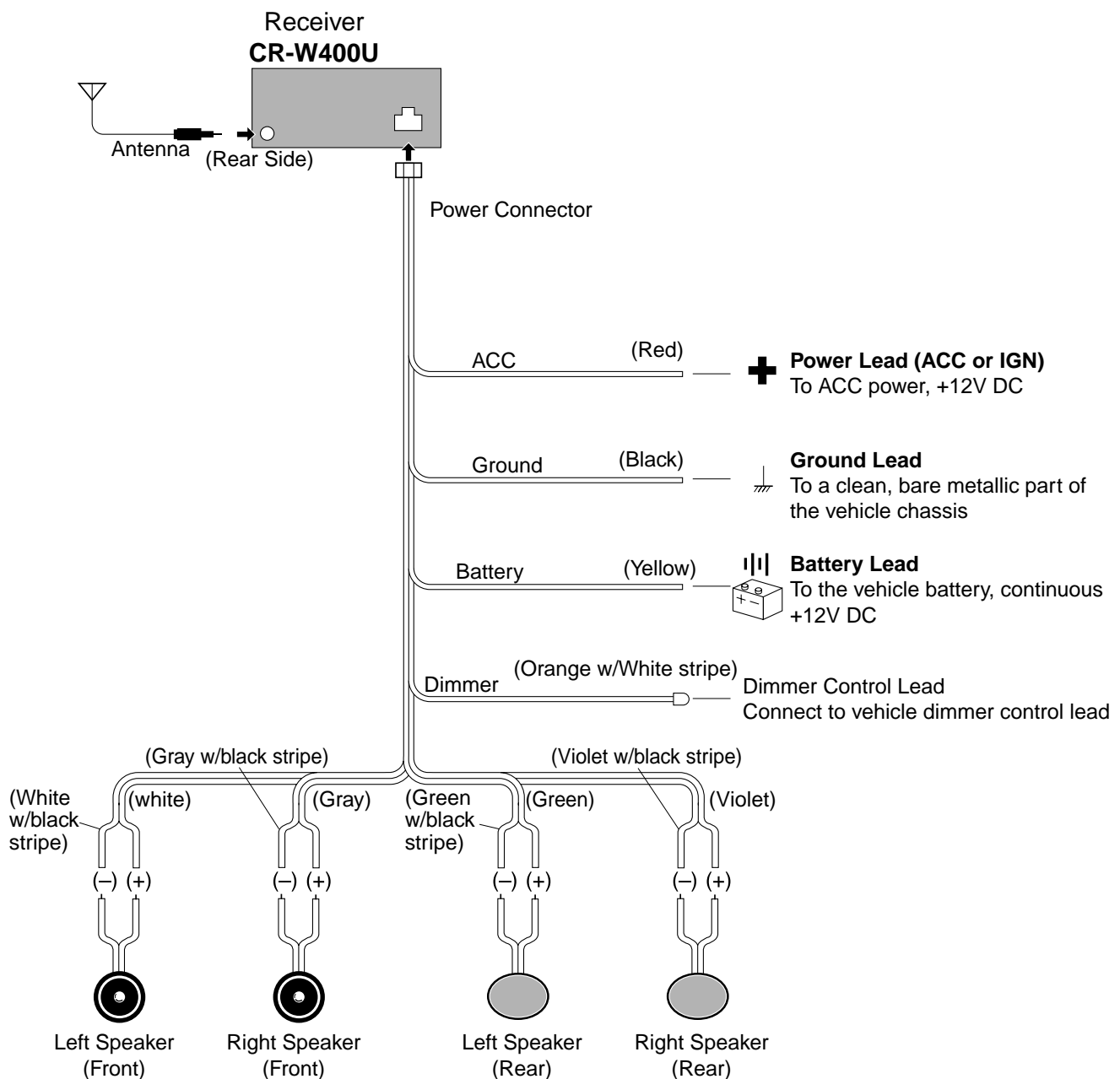

# Troubleshooting

---

---

## Maintenance

Your product is designed and manufactured to ensure a minimum of maintenance. Use a soft cloth for routine exterior cleaning. Never use benzine, thinner, or other solvent.

---

## Product Servicing

If the suggestions in the charts do not solve the problem, we recommend that you take it to your nearest authorized PASC service center. The unit should be serviced only by a qualified technician.

---

## When Something Doesn't Work

Check the charts on page 16 for possible causes and solutions to any problem you might be experiencing. Some simple checks or minor adjustments may eliminate the problem.



# Troubleshooting (continued)

---

## ❑ Troubleshooting Tips

PROBLEM	POSSIBLE CAUSE	PROBABLE SOLUTION
Unit does not turn on.	Dead vehicle battery Ignition or Acc is not on. Bad power line connection	Charge vehicle battery. Turn ignition to On or Acc. Check connections.
Radio has static.	Antenna not hooked up Close to high power lines	Hook up antenna. Move away from high power lines.
Radio memory buttons do not work.	Not holding buttons down long enough	Press and hold buttons for more than 2 seconds.
Inverted sound (Left/Right connections.)	The speaker cords are inverted.	Check the speaker cords.
No sound from front or rear speakers	The fader control is set on the wrong position.	Adjust the fader control of the unit correctly.

# Specifications

## General

Power Supply	: 12 V DC (11V-16V) Test Voltage 14.4V, Negative ground
Maximum Power Output	: 37W × 4 channels at 400 Hz, Volume Control maximum
Power Output	: 18W per channel into 4 ohms, 40 to 30,000Hz at 3% THD.
Tone Action	: Bass; ± 12 dB at 100 Hz Treble; ± 12 dB at 10 kHz
Current Consumption	: Less than 2.5 A (0.5W 4-speaker)
Speaker Impedance	: 4 Ω (4-8 Ω acceptable)
Dimensions (W × H × D)	: 7" × 1-15/16" × 5-7/8" (178 × 50 × 150 mm)
Weight	: 1 lbs. 14 oz. (0.85 kg)

## AM Radio

Frequency Range	: 530-1,710 kHz
Useable Sensitivity	: 28 dB/μV (25 μV/ S/N 20 dB)

## FM Stereo Radio

Frequency Range	: 87.9-107.9 MHz
Useable Sensitivity	: 12 dBf. (1.1 μV / 75Ω, S/N 30 dB)
50 dB Quieting Sensitivity	: 17 dBf. (1.8 μV / 75Ω)
Frequency Response	: 30-15,000 Hz ± 3 dB
Alternate Channel Selectivity	: 75 dB
Stereo Separation	: 35 dB at 1,000 Hz
Signal/Noise Ratio	: 70 dB (Mono)

## Weather Band Radio

Frequency Range	: 162.40-162.55 MHz
Useable Sensitivity	: 3 dB/μV (S/N 20 dB)
Signal/Noise Ratio (40 dB/μV)	: 50 dB

\*Above specifications comply with EIA standards.

**Note:** Specifications and design are subject to modification without notice due to improvements in technology.

# Part 15 of the FCC Rules

This unit has been manufactured under the Part 15 of the FCC Rules.  
Do not attempt to make any changes or modifications to this unit.



**Panasonic Consumer Electronics  
Company, Division of Matsushita  
Electric Corporation of America**  
One Panasonic Way, Secaucus,  
New Jersey 07094

YFM284C337ZA TAMACO0900-0 Printed in Taiwan